

## PARTS LIST

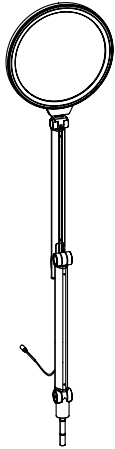

x1

Lamp



x1

Clamp



x1

(3mm 4mm)  
Hex Wrench

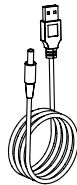

x1

Power Extension Wire

## WARRANTY SERVICE

Never worried when you choose viozon products  
We offer the best after-sale service to our  
customer, it only takes few minutes.

Just send you name and order number to



**US: [service@vio-zon.com](mailto:service@vio-zon.com)**

**EU: [support@vio-zon.com](mailto:support@vio-zon.com)**

And then you will get a complete service like The installation  
guide, Technical support, New product iteration, buy New  
similar products in advance , promotions, and warranty  
service from Viozon.

## FEEDBACK

**Share it?**  
Let us know with a customer review.

Viozon is focus on high-standard product, we believe  
Customer drive our product upgrades. And write a review  
that sharing your experience will help other customers , and  
this will give us great encouragement and confidence.

And if you have any questions, please feel free to contact us  
without hesitate.

FOR HELP PLEASE CONTACT US:



Facebook: Viozon



US [service@vio-zon.com](mailto:service@vio-zon.com)

EU [support@vio-zon.com](mailto:support@vio-zon.com)



[www.vio-zon.com](http://www.vio-zon.com)

**viozon**<sup>®</sup>

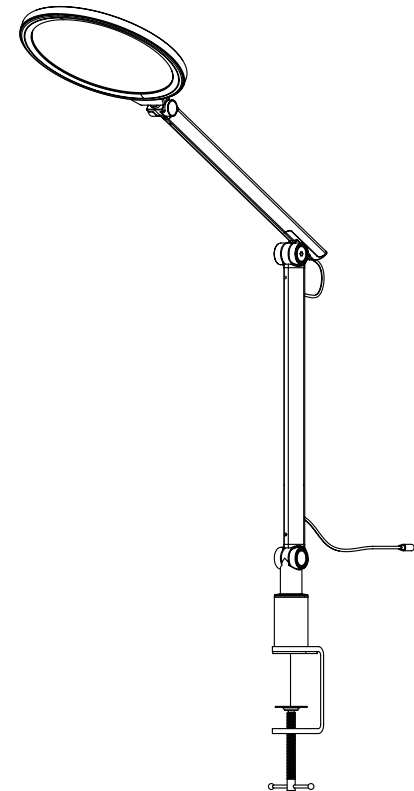

# LT-1C Installation Instructions

## 2.LAMP SET INSTALLATION

Insert the lamp set into the clamp.

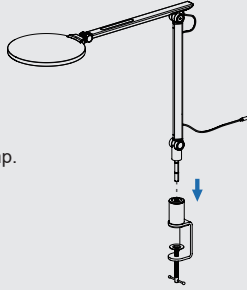

### Screw adjustment

Adjust the screw to hold the lamp body.

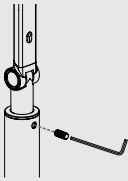

### Friction adjustment

If it feels too tight or loose in use, use a wrench to adjust the screws.



## 1.CLAMP INSTALLATION

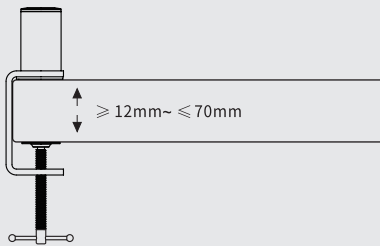

Adjust the height of the clamp to fit the table top, and then tighten the clamp.

## 3.LIGHT BUTTON DESCRIPTION

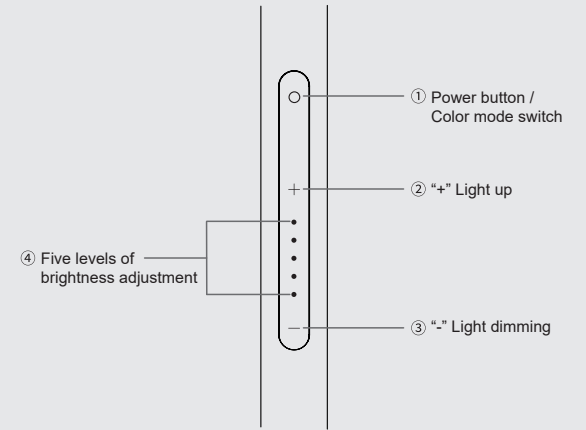

- 1 Power button/Color mode switch:** Long press to turn on the light. Click to adjust the color temperature. You can switch between cold light, warm light, and natural light. Long press again to turn off the light.
- 2 Light up:** Click the "+" to turn up the light, and the top level can be adjusted to the fifth level.
- 3 Light dimming:** Click the "-" to dim the light and the minimum level can be adjusted to the first level.
- 4 Five levels of brightness adjustment:** the light level 1~5 can be adjusted, according to your needs to adjust the appropriate brightness.

## LIGHT PARAMETERS

Product Name	LED Light
Diameter	7inches
Electricity Supply	5V/2A
Color Temperature	3100~6400K
Brightness	700LUX
CRI	>95
Operating temperature	-10~40°C
Materials	Aluminium alloy+PS/ABS